

perma lubrication systems for

Blowers & fans

H-T-L perma USA LP

2129 Center Park Drive
CHARLOTTE, NC 28217 / USA
www.permausa.com

Tel.: +1 704 377 3100

Toll Free: +1 800 997 3762

Fax: +1 704 377 3106

info@permausa.com

www.permausa.com

The Expert in Lubrication Solutions

perma

perma lubrication systems for **Blowers & fans**

Blowers and fans are used in almost all key industries. They provide adequate amounts of primary and secondary air. Flue gas fans remove air containing dust, gases and harmful substances. In primary air zones, induced draft fans are used such as in scrubbers, dust collectors, heat exchangers and desulfurisation plants.

- Mining & heavy industry
- Chemical industry
- Glass industry
- Wood-working
- Power plants (power generation)
- Food industry
- Refineries

Lubrication points

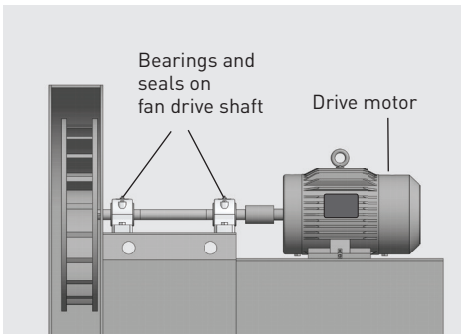

The lubrication points (roller bearings) are located at the **drive shaft** between drive motor and fan impeller.

Bearing and sealing of fan drive shaft is normally done by means of a pillow block housing or a bearing unit. These must be permanently supplied with the specified amount of the right lubricant.

Challenges

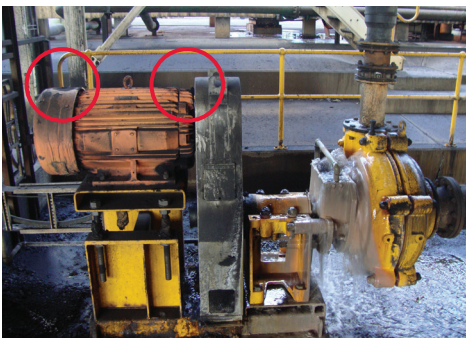

Fans and blowers are normally operated under **exceptional conditions**.

Contaminants such as dust or pumped media are dispersed by operation of the ventilator. These can enter the bearing system, which leads to increased wear of individual components and a shorter service life.

- Contaminants (e.g. **dust**) raised in the air must not enter the lubrication points

Regular lubrication of bearings and seals is imperative. Lubrication points are often extremely dirty and hard to reach, which makes maintenance even more difficult. Specified lubrication intervals are neglected or not observed for this reason. The resulting **lubrication starvation** leads to increased wear and in extreme cases to failure of the blowers and fans.

- **Excessive overheating of bearing points** due to lubrication starvation
- Lubricants must cope with the **demands** made of it, e.g. in terms of vibrations or high speeds
- **Observation of relubrication intervals** depending on bearing type, bearing size and ambient conditions



Advantages of automatic lubrication

- ✓ perma lubrication systems seal lubrication points and **protect against contamination**
- ✓ **Precise metering** of lubricant amount reduces lubricant consumption
- ✓ Safe and reliable lubrication, also in areas with **potentially explosive atmospheres**
- ✓ Different lubricant volumes for **exact adjustment to lubrication point**

perma SELECT APP

FREE



Solutions

Direct mounting on the lubrication point: e.g. with perma CLASSIC / FUTURA / FLEX / NOVA

- Easy, quick mounting
- For lubrication points with little vibration/shocks
- For easy-to-reach, safe lubrication points

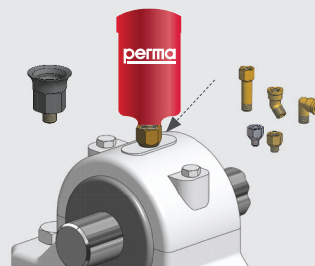

Direct Mounting Solution
Use extensions, angles & reducers depending on the installation situation

Remote mounting at lubrication point: e.g. with perma STAR VARIO

- For lubrication points with strong vibration/shocks (isolation of lubrication system)
- When workers' safety is at risk: Mounting in safe areas
- For hard-to-reach lubrication points

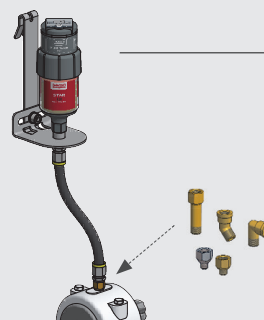

**perma STAR VARIO
with LC 120**

Remote Mounting Solution
Use extensions, angles & reducers depending on the installation situation

Applications



Industry: Waste incineration plant



Industry: Waste incineration plant



Industry: Quarrying



Industry: Power plant

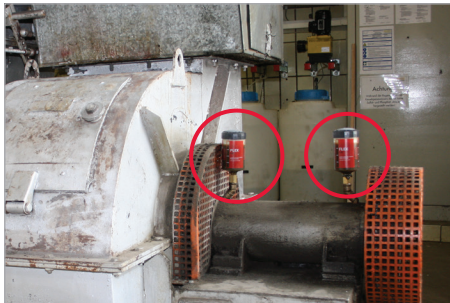

Industry: Chemical processing

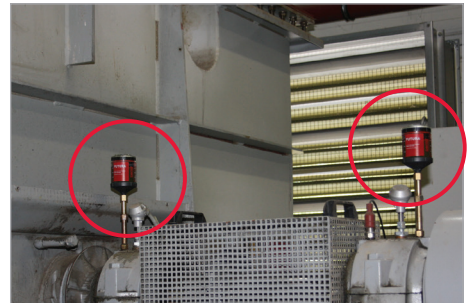

Industry: Quarrying



Industry: Coating plant

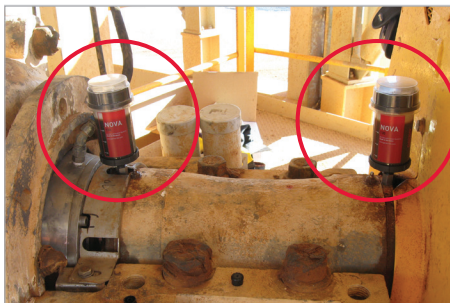

Industry: Quarrying



Industry: Quarrying

Individual solutions

perma Product portfolio



Solutions for all types of applications

perma Lubricants



Large selection of high quality lubricants to meet the requirements of your equipment

perma Accessories



Extensive range of accessories and connecting parts for your equipment

perma SERVICE



Project planning, installation and maintenance

perma SOFTWARE



Calculation of lubricant amount: • perma SELECT
Maintenance Lubrication Program: • perma MLP