

perma lubrication systems for

Electric motors

H-T-L perma USA LP

2129 Center Park Drive
CHARLOTTE, NC 28217 / USA
www.permausa.com

Tel.: +1 704 377 3100

Toll Free: +1 800 997 3762

Fax: +1 704 377 3106

info@permausa.com

www.permausa.com

The Expert in Lubrication Solutions

perma

perma lubrication systems for Electric motors

Electric motors are used for a variety of applications. An electric motor is designed to convert electrical into mechanical energy. Efficient lubrication and maintenance are essential for reliable operation of electric motors. Many motors are located in poorly accessible locations or in dangerous areas. They are therefore often only lubricated irregularly. Failure to adhere to manufacturer specifications frequently leads to damage and failures due to over-lubrication or lubrication starvation.

- Mining
- Power plants
- Food industry
- Recycling industry
- Quarrying industry
- Cement plants

Lubrication points

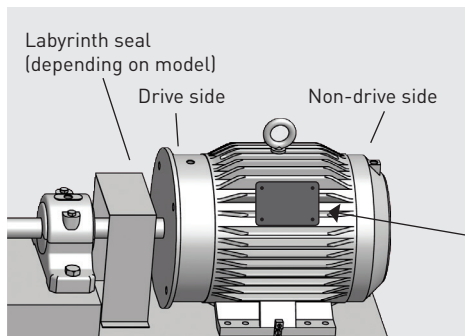

Lubrication points are located on the **drive and non-drive end of electric motors**. **Grease escape** (grease drain hole, grease relief ports or grease trap) also has to be taken into consideration. Bearings will overheat if grease cannot escape and/or if grease traps are filled up with used grease.

The correct lubricant
Motors with relubrication fittings come with information plates specifying grease amounts and relubrication intervals.

Speed high	Base oil thinner
Speed low	Base oil thicker

NLGI 0-2



Challenges



During manual lubrication, the grease is **applied in uneven amounts**. A large quantity of lubricant is introduced at one time. This leads to temporary **over-lubrication of the bearings**. Non-adherence to relubrication intervals leads to **lubrication starvation**.

- **Overheating** of bearings and **fire hazard**, since distribution of excess grease takes hours; **shut-off** by temperature monitoring
- Bearing damage due to lubrication starvation results in unscheduled **machine downtimes** and higher production costs
- **Increasing maintenance costs** caused by premature wear



Relubrication during running operation (manufacturer recommendation) jeopardises maintenance workers. Increased accident risk due to time spent in **dangerous** or **difficult-to-access** areas.

- **High accident risk**
- **Motor shut-down** when entering secured areas



Advantages of automatic lubrication

- ✓ **Relubrication during running operation** minimises overheating of bearings
- ✓ **Predictable exchange intervals** with reduced material and personnel expenditure
- ✓ **Increased workplace safety** due to automatic lubrication of hard-to-reach lubrication points
- ✓ Precise lubricant discharge **lowers** lubricant consumption and thereby **environmental impact**

perma SELECT APP

FREE



Solutions

Direct mounting on the lubrication point: e.g. with perma CLASSIC / FUTURA / FLEX / NOVA

- Easy, quick mounting
- For lubrication points with little vibration/shocks
- For easy-to-reach, safe lubrication points

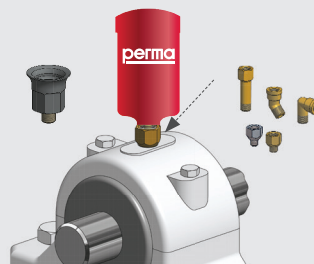
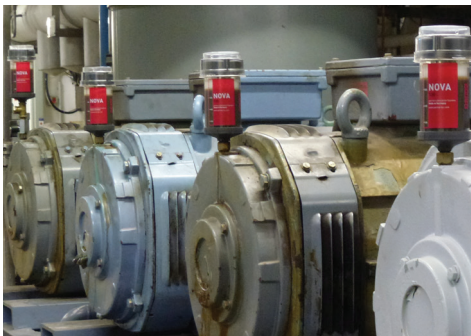

Direct Mounting Solution
Use extensions, angles & reducers depending on the installation situation

Remote mounting at lubrication point: e.g. with perma STAR VARIO

- For lubrication points with strong vibration/shocks (isolation of lubrication system)
- When workers' safety is at risk: Mounting in safe areas
- For hard-to-reach lubrication points

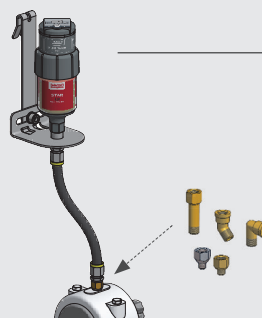
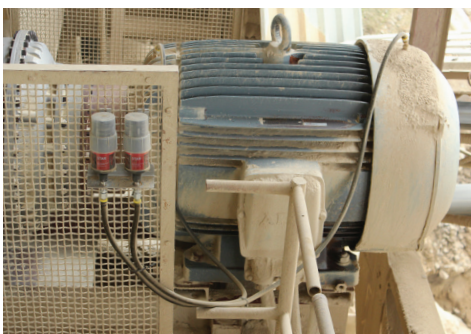

**perma STAR VARIO
with LC 120**

Remote Mounting Solution
Use extensions, angles & reducers depending on the installation situation

Applications



Industry: Power Generation

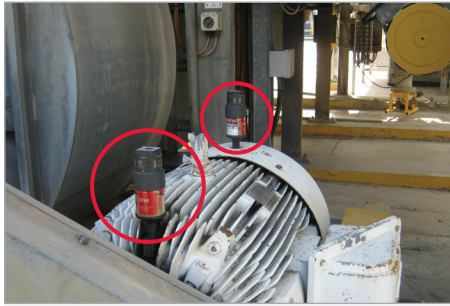

Industry: Mining



Industry: Cement

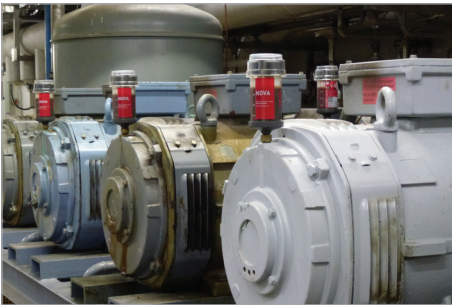

Industry: Automotive

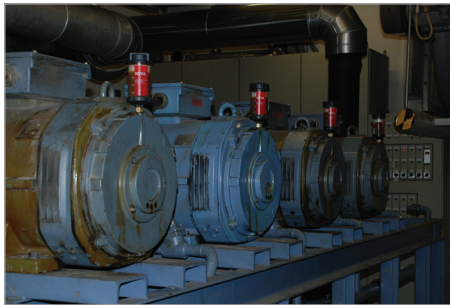

Industry: Waste incineration

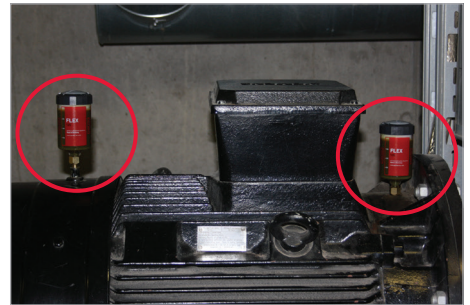

Industry: Wastewater

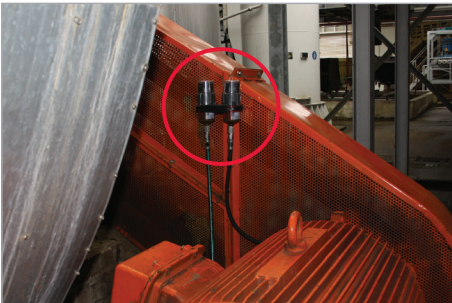

Industry: Wood

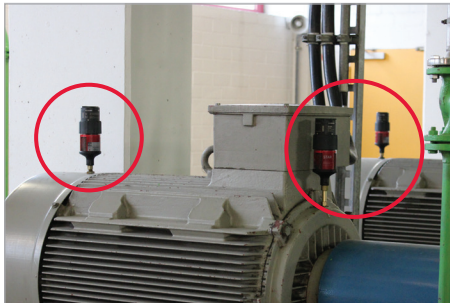

Industry: Power Generation



Industry: Blower

Individual solutions

perma Product portfolio



Solutions for all types of applications

perma Lubricants



Large selection of high quality lubricants to meet the requirements of your equipment

perma Accessories



Extensive range of accessories and connecting parts for your equipment

perma SERVICE



Project planning, installation and maintenance

perma SOFTWARE



Calculation of lubricant amount: • perma SELECT
Maintenance Lubrication Program: • perma MLP