

perma lubrication systems for

Pumps

H-T-L perma USA LP
2129 Center Park Drive
CHARLOTTE, NC 28217 / USA
www.permausa.com

Tel.: +1 704 377 3100
Toll Free: +1 800 997 3762
Fax: +1 704 377 3106
info@permausa.com
www.permausa.com

The Expert in Lubrication Solutions

perma

perma lubrication systems for Pumps

Pumps are the core of many industrial applications. A failing pump can often interrupt the entire work or production process. All sorts of pumps are used in many fields and applications. Appropriate lubrication safeguarding the work and production process of the pump is a decisive factor of smooth operation.

- Mining & heavy industry
- Chemical industry
- Power generation
- Food industry
- Oil and gas production
- Paper industry
- Pharma industry
- Environmental technology
- Water and wastewater

Lubrication points

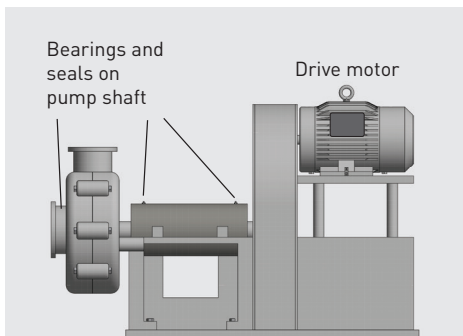

Lubrication points (roller bearings) are located on the **drive shaft** between drive motor and pump body or in the pump housing.

Lubrication of **packing gland** and **labyrinth seals** prevents the ingress of dirt and/or pumped media. **Bearings** and **bearing housing seals** must be permanently supplied with the specified amount of the right lubricant.

Challenges

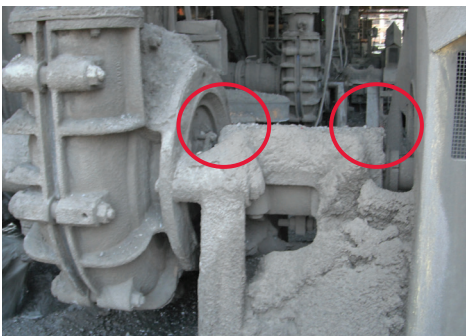

Pumps are often operated under extreme conditions, subjecting individual components to special wear. These can include **heavy contamination** from slurry or dust, as well as **hazardous materials** such as bases and weak acids.

- **Dirt, water or other contaminants** must not enter the bearing points

Lubrication points can often only be accessed using **extreme protective measures** (safety gloves and mask). This frequently leads to neglect of or non-compliance with the prescribed lubrication.

Lubrication starvation results in wear, which leads to **failure of equipment components** or pump **leakages**.

- Optimal and regular **lubrication with fresh lubricant** during equipment operation
- Operation in **potentially explosive areas**
- **Workplace safety** must be ensured

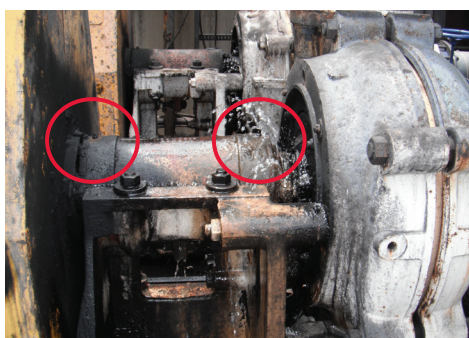



Advantages of automatic lubrication

- ✓ **Increased workplace safety** due to automatic lubrication of hard-to-reach lubrication points
- ✓ Precise lubricant discharge **lowers** lubricant consumption and thereby **environmental impact**
- ✓ **Fewer maintenance runs** minimise the time workers spend in dangerous areas
- ✓ Depending on the selected lubrication system, use may be possible **underground** or in **potentially explosive areas**

perma SELECT APP

FREE



Solutions

Direct mounting on the lubrication point: e.g. with perma CLASSIC / FUTURA / FLEX / NOVA

- Easy, quick mounting
- For lubrication points with little vibration/shocks
- For easy-to-reach, safe lubrication points



Direct Mounting Solution
Use extensions, angles & reducers depending on the installation situation

Remote mounting at lubrication point: e.g. with perma STAR VARIO

- For lubrication points with strong vibration/shocks (isolation of lubrication system)
- When workers' safety is at risk: Mounting in safe areas
- For hard-to-reach lubrication points

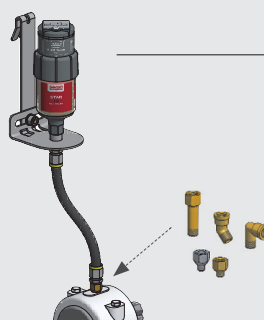

**perma STAR VARIO
with LC 120**

Remote Mounting Solution
Use extensions, angles & reducers depending on the installation situation

Applications

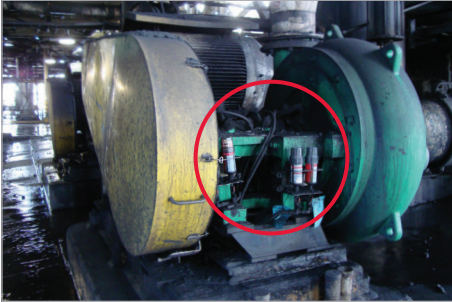

Industry: Mining



Industry: Mining

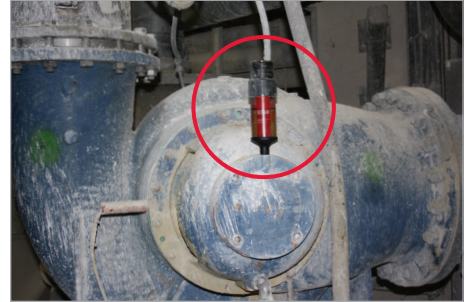

Industry: Pulp and Paper



Industry: Power generation



Industry: Pulp and Paper

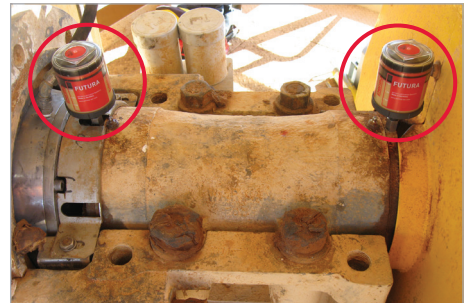

Industry: Quarrying



Industry: Wastewater



Industry: Mining

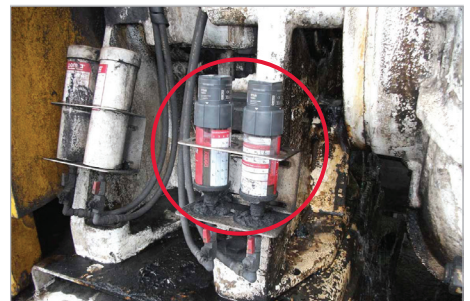

Industry: Mining

Individual solutions

perma Product portfolio



Solutions for all types of applications

perma Lubricants



Large selection of high quality lubricants to meet the requirements of your equipment

perma Accessories



Extensive range of accessories and connecting parts for your equipment

perma SERVICE



Project planning, installation and maintenance

perma SOFTWARE



Calculation of lubricant amount: • perma SELECT
Maintenance Lubrication Program: • perma MLP